

H.P.A.

High Performance Alarm

INSTALLER'S MANUAL
Release 02



Dear Installer,

Congratulations on your choice of a MetaSystem product! We would like to ask you to read the instructions in this manual carefully as you will find it contains useful information to get acquainted with the many possibilities that the H.PA (High Performance Alarm) range of products is able to offer.

After you have installed the product according to the “installation instructions” supplied with the product, and which you will also find below, the alarm control unit must be programmed in order to customise the product based on the vehicle that it is installed on.

When you have finished the job, it is important to remember to give the user’s handbook to the owner of the vehicle and to show him the various features of his car alarm system. Please remember to fill out the “certificate of installation” in the user’s handbook (European Directive) and to give the owner the red card that he will need should he decide to order any extra remote controls, as well as the OVERRIDE CARD where you should have already written the owner’s emergency code, customised according to his choice.

Best Regards !

INDEX

- Introduction	3
- The Range of H.PA. products	4
- Technical specifications	5
- Instructions for installation	6
- Customising the operating functions	8
- Checking the setting of the operating functions	8
- Description of the operating functions	9
- The override code	12
- Remote controls	15
- Emergency keys	15
- Checking the remote controls and emergency keys	15
- The garage function	16
- The control unit’s power supply	16
- Memory of triggered alarms	16
- Final Check	16
- Instructions for use	17

THE H.P.A. RANGE Rel.02	HPA 2,5	HPA 3,0	HPA 3,5	HPA 4,0
ARMING / DISARMING	•	•	•	•
2-button remote control with programmable function buttons – random rolling code	•	•	•	•
Passive arming of alarm – selection according to preference	•	•	•	•
Passive arming of immobiliser– selection according to preference	•	•	•	•
'Distraction-proof' re-arming - selection according to preference	•	•	•	•
Emergency override code – customised according to preference	•	•	•	•
Electronic emergency key - random rolling code	OPT	OPT	OPT	OPT
Key 4 keypad	OPT	OPT	OPT	OPT
IMMOBILISER	•	•	•	•
Relay for engine immobilisation (10A)	•	•	•	•
ALARM: protection and signals	•	•	•	•
Protection of doors/bonnet/boot – negative input – 3 wires	•	•	•	•
Auxiliary protection – positive input – can be excluded by remote control	•	•	•	•
Digital ultrasonics with programmable adjustment of sensitivity – can be excluded by remote control	•	•	•	•
Current drop sensor –selection according to preference	•	•	•	•
Ignition sensing	•	•	•	•
Panic alarm - selection according to preference	•	•	•	•
Anti carjacking with triggering of alarm and immobilisation of ignition (3 modes can be selected)	•	•	•	•
Safety lock - automatic locking of doors when travelling (input for mileometer or brake pedal) - selection according to preference	•	•	•	•
Buzzer - selection according to preference	•	•	•	•
Blinker	•	•	•	•
M02 siren without battery back up	•	•	•	•
SC1 coded siren with battery back up				
Output for control of continuous/alternating siren/horn - selection according to preference	•	•	•	•
SERVICES				
LED with memory of triggered alarms	•	•	•	•
Switch/LED for override code	•	•	•	•
Universal central door locking – 6 wires – with selection of timing	•	•	•	•
Control of original comfort closing of electric windows or via remote control - selection according to preference	•	•	•	•
Control of safety dead lock on central locking - selection according to preference	•	•	•	•
Control of automatic electric windows module (M8) or via remote control (M2008) - selection according to preference	•	•	•	•
Exclusion of ultrasonics and auxiliary protection by remote control	•	•	•	•
Garage function – exclusion of passive arming	•	•	•	•
Signals if car battery is flat	•	•	•	•
Signals open doors/ tests alarm inputs	•	•	•	•

TECHNICAL SPECIFICATIONS

Power Supply.....	12Vdc (10V-15V)
Consumption.....	(alarm armed with ultrasonics) 10 mA
.....	(alarm armed without ultrasonics) 8 mA
.....	(alarm disarmed) 6 mA
Operating temperature.....	-25°C+ 85°C
Sound level of siren.....	118 dB
Autonomy of back-up battery (SC1).....	5 minutes.
Remote controls (max.7).....	72 million billion rolling codes (lithium batteries)
Emergency keys (max 4).....	18 billion billion rolling codes
Emergency "override" code to reset immobiliser and inhibit alarm functions.	

RELAY CONTACT CAPACITY

Central door locking.....	10A
Engine immobiliser relay.....	10A
Direction indicators relay.....	5A+5A
Horn control.....	Negative electronic 1A

TIMING

Initial immunity time.....	26 seconds
Duration of alarm cycle.....	26 seconds
Interval between alarm cycles.....	5 seconds
Delay for passive arming of engine immobiliser.....	(with engine off) 240 seconds
.....	(with door open - engine off) 50 seconds
Delay for passive arming with alarm functions.....	30 seconds
Intermittence of direction indicators when alarm triggered.....	0.4 sec.on
.....	0.4 sec.off
Timing options for opening – closing doors.....	0.5 sec.-1.5 sec.-4.5 sec.-15 sec.
Timing for comfort closing.....	0.5-15 sec.
N° of permitted times for starting vehicle in garage mode.....	15
'Distraction-proof' re-arming.....	120 seconds

ALARM CYCLES

Peripheral alarm inputs (doors, bonnet, boot).....	10 cycles
Ignition sensing.....	10 cycles
Ultrasonics.....	10 cycles
Auxiliary modules.....	10 cycles
Current drop sensor.....	10 cycles

INSTRUCTIONS FOR INSTALLATION

INSTALLATION

CONNECT CAR BATTERY

INSTALLATION OF SIREN UNDER BONNET

INSTALLATION OF ULTRASONIC VOLUME PROTECTION

CONNECTIONS

GENERAL WIRING DIAGRAM

CONNECTION OF KEY 4 KEYPAD (OPT)

CONNECTION OF ELECTRONIC EMERGENCY KEY (OPT)
(cannot be used if KEY 4 KEYPAD is connected)

DIRECTION INDICATORS	↔	LIGHT BLUE	
DIRECTION INDICATORS	↔	LIGHT BLUE	
IMMOBILISER	🚫	DARK BLUE WHITE	
NEGATIVE CONTROL OF HORN RELAY	📣	BROWN	
* DOOR PROTECTION	🚗	GREEN	
* BONNET PROTECTION	🚗	PURPLE	SEE FIG.3
* BOOT PROTECTION	🚗	PURPLE	
M02 SIREN (H.P.A. 2.5-3.5)	📢	BLACK BLACK	SEE FIG.5
SC1 SIREN (H.P.A. 4.0)	📢	RED RED/BLUE BLACK	SEE FIG.6
POSITIVE ALARM INPUT	🚗	YELLOW	
ANTI CARJACKING SWITCH (OPT)	🚗	BLACK RED	
BATTERY POSITIVE (+30)	🔋		

	MOUNT 15A FUSE	RED	
		BLACK	EARTH
		LIGHT BLUE/WHITE (C)	
		LIGHT BLUE/YELLOW (NO)	CONTROL OF CLOSING
		LIGHT BLUE/BLACK (NC)	
		RED/WHITE (C)	
		RED/YELLOW (NO)	CONTROL OF OPENING
		RED/BLACK (NC)	
		ORANGE	POSITIVE IGNITION KEY (+15)
		PINK	AUX POSITIVE CONTROL OF AUXILIARY MODULES
		GREEN/BLACK	MILEOMETER SIGNAL
		PINK/BLACK	CONTROL OF ELECTRIC WINDOWS (M2008 OPT)

* = ONLY USE THE EXISTING SWITCHES IF THEY CLOSE TO EARTH

PERIPHERAL PROTECTION – DOORS *

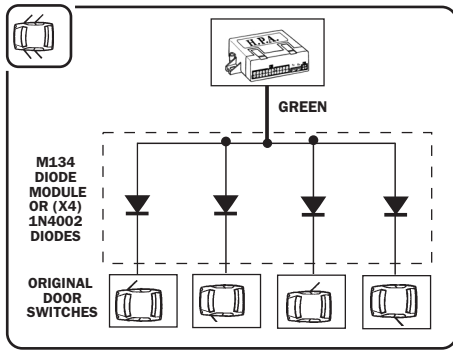

PERIPHERAL PROTECTION – BONNET *

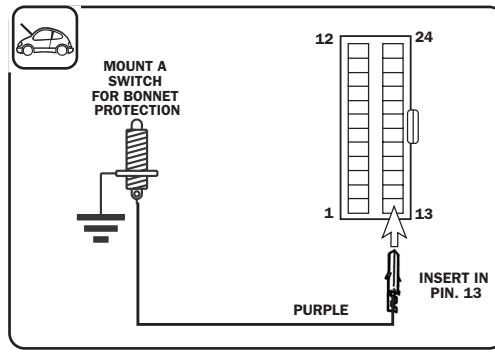

PERIPHERAL PROTECTION – BOOT *

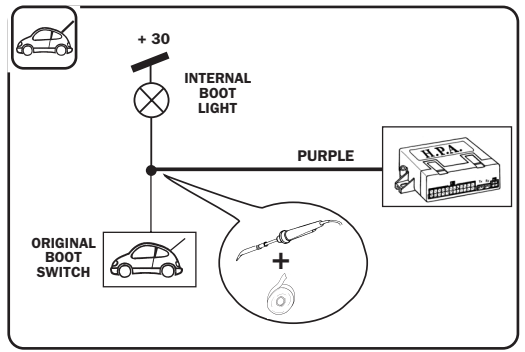

SIREN FOR H.P.A. 2.5 -3.5

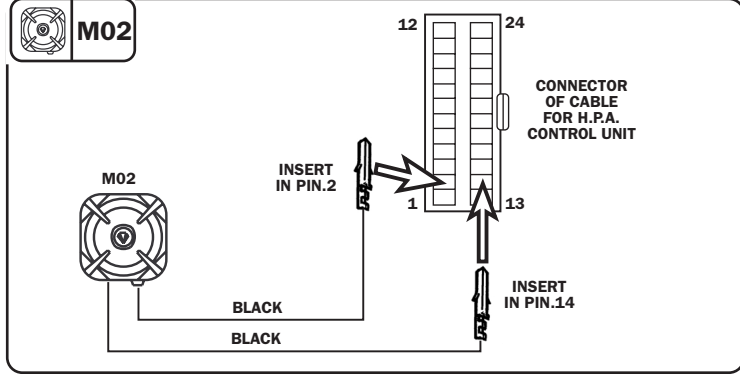

SIREN FOR H.P.A. 4.0

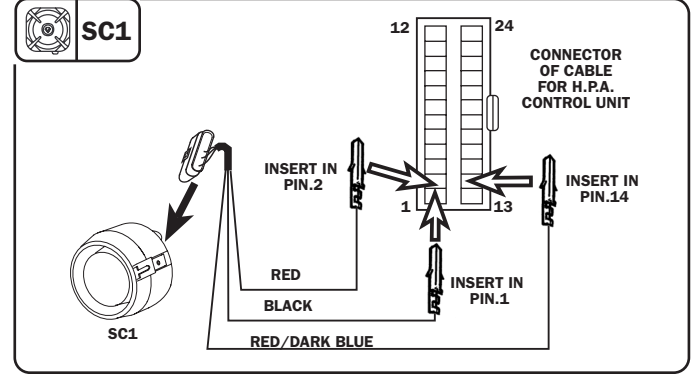

WIRING DIAGRAM FOR NEGATIVE CENTRAL LOCKING

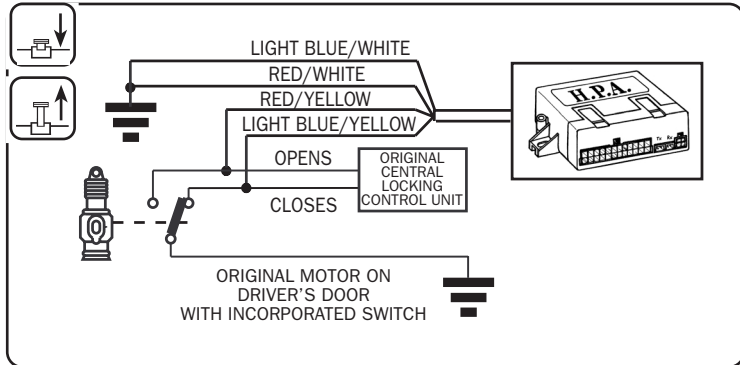

WIRING DIAGRAM FOR POSITIVE CENTRAL LOCKING

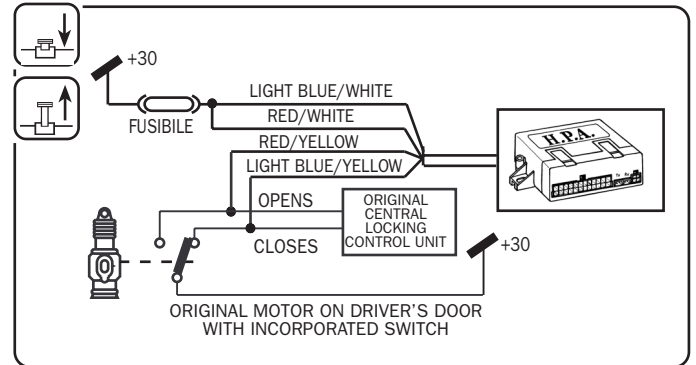

IMMOBILISATION

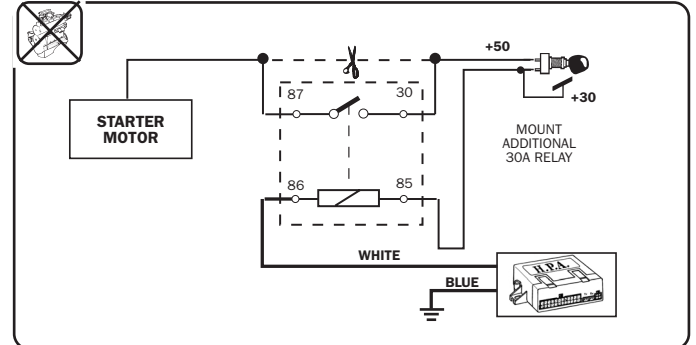
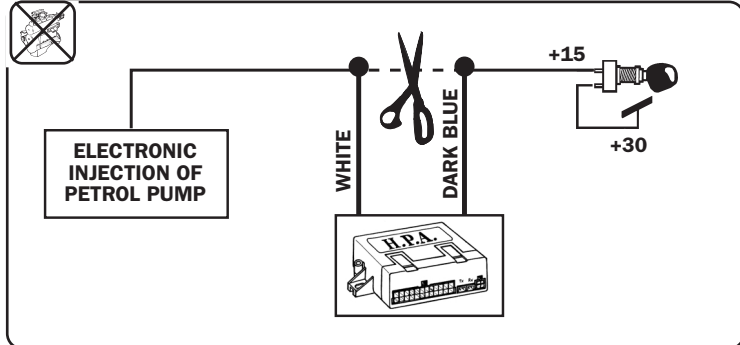

HORN WITH POSITIVE CONTROL- SUBKEY

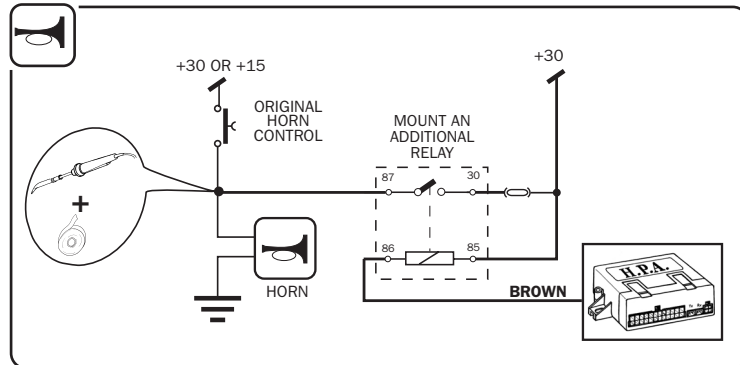

HORN WITH NEGATIVE CONTROL- SUBKEY

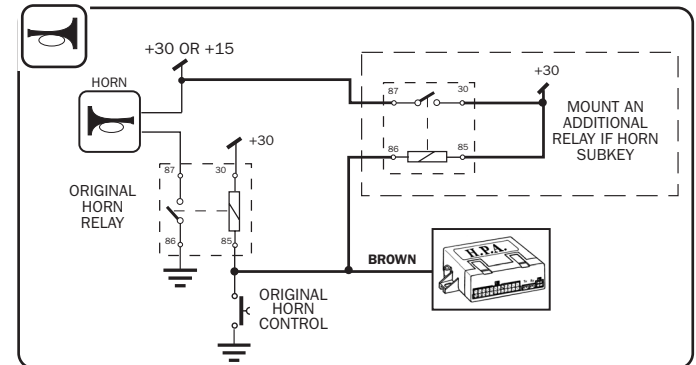

CUSTOMISING THE OPERATING FUNCTIONS

The installed alarm system has a series of preset factory settings, which can be modified according according to the vehicle that the alarm system is to be installed on as well as the owner's preferences.

The factory settings and their possible customisations are illustrated in the table below.

N°	TYPE OF FUNCTION	BUTTON A selection A (flashing led)	BUTTON B selection B (led off)	FACTORY SETTING standard configuration
1	buzzer	yes	no	no
2	control of horn/siren	continuous	alternating	alternating
3	safety lock	yes	no	no
4	sensibility of volume protection	standard	reduced	standard
5	current drop sensor	yes	no	no
6	short timing for central door locking	0,5 sec	function 7	0,5 sec
7	long timing for central door locking	1,5 sec	4,5 sec	1,5 sec
8	comfort closing	yes-manual	no	no
9	automatic comfort	yes	no	no
10	dead lock	yes	no	no
11	control of electric windows	automatic	manual	manual
12	panic alarm	yes	no	no
13	test of peripheral alarms	yes	no	yes
14	intentional anti carjacking function	yes	no	no
15	automatic anti carjacking function 1	yes	no	no
16	automatic anti carjacking function 2	yes	no	no
17	not used	--	--	--
18	siren supplied	SC1	M02	according to kit
19	Key 4 keypad	yes	no	no
20	control of safety locking	brake pedal	mileometer	mileometer
21	distraction-proof rearming	yes	no	no
22	function of remote control buttons	factory setting	custom setting	factory setting
23	passive arming with alarm functions	yes	no	no
24	passive arming of immobiliser	yes	no	no
25	peripheral alarms active	derived 1 alarm only	continuous	derived

Proceed as follows to modify the factory setting:

- arm the alarm system with the remote control;
- turn the ignition key to its ON position in order to switch the vehicle's dashboard on;
- press button A on the remote control 4 times (fig. 1): the direction indicators will flash each time the button is pressed;
- after the button is pressed for the fourth time, the siren will make a series of signals (M02=4 BOOPS - SC1=4 BIP- BIPS) to confirm that you have accessed the programming mode for the operating functions: the LED flashes quickly

N.B. you can only modify one function at a time.

- Press the button on the SWITCH/LED module installed on the dashboard or press button 1 on the keypad, if present, for the same number of times as the function you want to set (the direction indicators flash to confirm each time you press the button and go from one function to the next): if the LED flashes slowly the setting of the function is the "A selection" type, if it remains off the setting is the "B selection" type;

The Led flashes quickly to indicate that a 'not used' function has been selected

- to change the setting, press
 - button A on the remote control if you want the setting as per "A selection": the siren makes one BEEP sound to confirm this, or press
 - button B on the remote control if you want the setting as per "B selection": the M02 siren makes one BOOP sound to confirm this; if you have installed a SC1 siren, this will make 2 BIP sounds;
- to change the setting of another function, repeat the 2 previous steps within 20 seconds;
- to exit the operating functions customisation phase, turn the ignition key back off and switch the vehicle's dashboard off, then disarm the system by pressing button A on the remote control.

N.B. During selection of a function, if you press the button on the SWITCH/LED or button 1 on the keypad, if present, for a number of times that corresponds to a function which is not used or one that does not exist, you will hear 4 BOOPS of the M02 siren or 8 BIPS of the SC1 siren when you press the button on the remote control, and the LED will flash quickly to indicate the anomaly.

CHECKING THE SETTING OF THE OPERATING FUNCTIONS

When customising the operating functions, you can check the status of each individual setting. The LED will indicate the current setting after you have pressed the button on the SWITCH/LED or button 1 on the keypad, if present, the same number of times as the function you want to check, as follows:

- slow flashing = "A selection" type setting
- off = "B selection" type setting

DESCRIPTION OF THE OPERATING FUNCTIONS

1 - **BUZZER** - Factory Setting: disabled

The acoustic signal provided by the siren when the alarm system is armed and disarmed. Its use is not permitted in countries in the European Community.

2 - **CONTROL OF HORN/SIREN** - Factory Setting: alternating

Negative signal (1A max) to control the horn or additional siren during an alarm cycle.

Select alternating to control a horn, continuous to control a siren.

3 - **SAFETY LOCK** - Factory Setting: disabled

This function guarantees that the doors will always be locked via the central door locking system when the vehicle is in motion, and thus prevents any attempt to open the doors from the outside. The doors are locked automatically with the timing selected for UNLOCK TIMING. The LOCKING control is performed according to the selection made for function 20 and the relative connection of the green/black wire. In fact it is possible to select the door locking control whilst the vehicle is in motion if it comes from the mileometer wire or the brake pedal.

MILEOMETER (connect the green/black wire from the alarm control unit to the vehicle's mileometer signal). The locking control is performed after the ignition is switched on, the doors are locked and the vehicle has been in motion for at least 10 seconds. BRAKE PEDAL (connect the green/black wire from the alarm control unit to the vehicle's brake pedal). The locking control is performed the second time the brake pedal is pressed if the doors are locked and the instrument panel is on (+15 ON) The INTENTIONAL ANTI-CARJACKING and ANTICARJACKING 1 functions are not possible with this selection. The doors will only be unlocked if a door is opened from the vehicle interior or if the engine is turned off.

4 - **SENSITIVITY OF VOLUME PROTECTION** - Factory Setting: standard

The particular technology used for the ultrasonic volume protection results in only real attempts to break into the vehicle interior being detected and false alarms being ignored. We recommend the use of reduced sensitivity for vehicles with a small interior (for example double volume vehicles).

5 - **CURRENT DROP SENSOR** - Factory Setting: disabled

As the alarm is being armed, the control unit memorises the consumption of the vehicle's electrical system and triggers an alarm if there is any variation in this. WARNING: the current drop sensor cannot replace peripheral protection because the current drop sensor will remain inactive if the bulb in the vehicle's interior light does not come on when a door is opened. N.B. To ensure correct operation of the current drop sensor, do not connect the alarm's positive supply directly to the battery, but to a derived line (e.g. fuse box). If operation of the current drop sensor has been selected, the 4 direction indicators can still be used in case of emergency without triggering an alarm even if the alarm is armed.

6_7_8_9 - **TIMING FOR CENTRAL DOOR LOCKING** - Factory Setting: 0.5 seconds, comfort disabled
It is possible to select the timing for locking and unlocking of the central door locking system from between 0.5 sec, 1.5 sec and 4.5 seconds.

In addition, if the comfort function is selected, the locking time depends on how long the button on the remote control is kept pressed, for up to maximum of 15 seconds. If the button is released before the 15 seconds are over, the control of the locking will be interrupted. If the automatic comfort function is selected, the locking time will be fixed at 15 seconds. When the comfort function is operational, the duration of the unlocking control can be 0.5 sec, 1.5 sec and 4.5 seconds. The possibilities for selection are shown in the table below

LOCKING TIME	UNLOCKING TIME	SETTING OF FUNCTIONS 6 - 7 - 8 - 9			
short = 0,5 sec.	short = 0,5 sec.	6 = selection A	7 = selection A	8 = selection B	9 = selection B
medium = 1,5 sec.	medium = 1,5 sec.	6 = selection B	7 = selection A	8 = selection B	9 = selection B
long = 4,5 sec.	long = 4,5 sec.	6 = selection B	7 = selection B	8 = selection B	9 = selection B
manual comfort 0,5÷15 sec.	short = 0,5 sec.	6 = selection A	7 = selection A	8 = selection A	9 = selection A
	medium = 1,5 sec.	6 = selection B	7 = selection A	8 = selection A	9 = selection A
	long = 4,5 sec.	6 = selection B	7 = selection B	8 = selection A	9 = selection A
automatic comfort 0,5÷15 sec.	short = 0,5 sec.	6 = selection A	7 = selection A	8 = selection A	9 = selection A
	medium = 1,5 sec.	6 = selection B	7 = selection A	8 = selection A	9 = selection A
	long = 4,5 sec.	6 = selection B	7 = selection B	8 = selection A	9 = selection A

10 - **DEAD LOCK** - Factory Setting: disabled

This function allows you to control an additional feature of the central door locking system using your remote control as it controls the safety locking of the vehicles with this system (Opels, recent Fiats etc) when both locking and unlocking the doors. The locking and unlocking controls are activated for the time set as per functions 6_7_8_9 and then are reactivated for a further 0.5 sec after a pause of 0.5 sec. for locking and 1 sec for unlocking.

The Dead Lock controls are not produced during the activation of the Safety Lock function (if enabled).

11 - **CONTROL OF ELECTRIC WINDOWS** - Factory Setting: manual

This control makes it possible to control the closing of the vehicle's electric windows by means of the M2008 module (optional) or to control the vehicle's original control box. Manual mode can be selected for the M2008 module, which enables the windows to be closed for as long as the button on the remote control is being pressed (12 sec max). If the button is released before the 12 sec timing is over, the closing of the windows will stop. Automatic mode is to close the windows with 12 sec timing with one press of the button on the remote control.

It is possible to prevent the closure of the electric windows for one cycle of arming/disarming of the alarm system; this is useful in summer if you want to leave the vehicle parked with its windows slightly opened or if you have to leave a pet in the car. Press the button on the SWITCH /LED or button 1 on the keypad, if present, before arming the alarm system with the remote control. The alarm system must then be armed within 60 sec of pressing the SWITCH /LED

12 - **PANIC ALARM** - Factory Setting: disabled

This function allows you to trigger a max 10 sec alarm cycle with the remote control; it can also be interrupted by remote control. Its operation depends on the setting of FUNCTION OF REMOTE CONTROL BUTTONS (function 22): FACTORY SETTING: when the control unit is not armed, trigger this function by pressing button B on the remote control; the same button can be used within 10 seconds to interrupt it. If the control unit is armed, the function can be triggered after the initial immunity time by pressing button B. Press it again within 10 sec, to stop the panic alarm.

CUSTOM SETTING: when the control unit is armed, the function can be triggered after the initial immunity time by pressing button A. Press it again within 10 sec to stop the panic alarm. It is not possible to trigger a panic alarm if the control unit is not armed.

13 - **TEST OF PERIPHERAL ALARMS** - Factory Setting: activated

If the vehicle has an internal light with delayed switch off, or with particular connections, the alarm control unit could interpret this as an open door when it is armed, resulting in 1 BOOP signal for the M02 siren or 2 BIPS for the SC1 siren. If this is the case, we recommend neutralizing this function to eliminate the inaccurate signal.

ANTI CARJACKING FUNCTION

Only one anti carjacking method mode can be enabled at a time: when one method is enabled the other two are automatically neutralised. If the brake pedal has been enabled in the Safety Lock function (see Function 3), the activation of INTENTIONAL ANTI CARJACKING mode and AUTOMATIC ANTICARJACKING 2 is also neutralised.

14 - INTENTIONAL ANTI CARJACKING FUNCTION - Factory Setting: disabled

Conditions a, b and c must be met if this function is required.

a) The dedicated anti-carjacking switch must be installed (see wiring diagram for details on connection); this must be located in a place that is not visible but is within easy reach of the driver.

b) To ensure correct operation of this function (European Directive), it is absolutely essential to interrupt the operation of the vehicle's starter motor with the dark blue and white wires from the alarm control unit.

c) It is also necessary to connect the green/black wire from the alarm control unit to the mileometer signal from the vehicle. In case of danger, this function enables the activation of a timed procedure that triggers an alarm cycle and prevents the engine being started. After the anti-carjacking switch has been pressed (the LED will flash once), the ignition will be immobilised if the vehicle has been in motion for at least 1 minute and then has stopped (speed 0) for at least 5 seconds. A 25 second alarm cycle indicates that the ignition immobilisation protection has been activated. If the engine is now turned off, it is only possible to turn it back on 3 times, and then the vehicle will be totally immobilised. The remote controls are neutralised after this function has been armed and it is only possible to exit it by means of the OVERRIDE code.

15 - AUTOMATIC ANTI CARJACKING FUNCTION 1 - Factory Setting: disabled

Conditions a and b must be met if this function is required.

a) The dedicated anti-carjacking switch must be installed (see wiring diagram for details on connection); this must be located in a place that is not visible but is within easy reach of the driver.

b) To ensure correct operation of this function (European Directive), it is absolutely essential to interrupt the operation of the vehicle's starter motor with the dark blue and white wires from the alarm control unit.

This function protects the vehicle in case of unauthorised use by triggering an alarm cycle and preventing the engine from being started. Every time a door is opened and the vehicle starts up, the direction indicators will flash for a set time unless the anti carjacking switch is pressed, followed by the immobilisation of the ignition and the sounding of the siren. The anti carjacking switch must be pressed after the door has been opened and the ignition is started, keeping it pressed until the LED flashes once. If it is not pressed within max 20 seconds of the ignition being started, there will be a continual series of BEEPS by the siren and flashing of the direction indicators for 30 seconds, followed by the flashing of the direction indicators alone for another 90 seconds, to remind the driver to press the appropriate switch. If he still does not press the switch, an alarm cycle will be triggered and the ignition will be immobilised. If the engine is now turned off, it is only possible to turn it back on 3 times, and then the vehicle will be totally immobilised. It is only possible to exit this function after it has been armed by means of the OVERRIDE code.

16 - AUTOMATIC ANTI CARJACKING FUNCTION 2 - Factory Setting: disabled

Conditions a, b, c, d and e must be met if this function is required.

a) The optional KEY 4 keypad must be installed

b) To ensure correct operation of this function (European Directive), it is absolutely essential to interrupt the operation of the vehicle's starter motor with the dark blue and white wires from the alarm control unit.

c) It is also necessary to connect the green/black wire from the alarm control unit to the mileometer signal from the vehicle.

d) Function 19 must be enabled by selecting A during the 'Customising The Operating Functions' stage

e) Store the velocity signal for the vehicle not in motion and the maximum speed allowed. (refer to the 'Memorising the mileometer frequency' section)

This function protects the vehicle in case of unauthorised use by triggering alarm cycles and preventing the engine from being started. Every time a door is opened and the vehicle starts up, the Led will light up and the buzzer will sound on the keypad, the direction indicators will flash, the siren or horn output will be activated for a set time, followed by the immobilisation of the ignition unless the 4-digit password is keyed in using the keypad. Once the vehicle is in motion, the remote controls will be neutralised until the correct code is keyed in using the keypad.

ACTIVATION

The following events must occur, in any order:

- closure of last open door

- instrument panel switched on (+15 ON)

- vehicle immobile (not in motion) for at least 2 sec.

If the correct password is keyed in when the instrument panel is on (+15 ON), this function is neutralised.

If the wrong password is keyed in when the instrument panel is on (+15 ON), the system goes onto the next stage.

START OF INTERNAL SIGNALLING

If the correct password is not keyed in within 180 sec. from when the vehicle starts moving, the LED and the BUZZER on the KEY 4 keypad are activated intermittently. If the wrong password is keyed in during this 180 sec period, the LED and the BUZZER immediately become active. If the engine is turned off (+15 OFF) during this 180 sec period, the countdown is immediately interrupted until the instrument panel is turned on again (+15 ON). After the 180 sec period, the LED and the BUZZER are activated intermittently for 60 sec

If the correct password is keyed in when the instrument panel is on (+15 ON), this function is neutralised.

If the wrong password is keyed in when the instrument panel is on (+15 ON), the system goes onto the next stage.

START OF EXTERNAL SIGNALLING

45 sec after the start of internal signalling (the LED and BUZZER) without the correct password being keyed in, the siren, horn output and the direction indicators are activated. (180+45 sec from the moment when the vehicle started moving).

If the correct password is keyed in when the instrument panel is on (+15 ON), this function is neutralised.

If the wrong password is keyed in when the instrument panel is on (+15 ON), the system goes onto the next stage.

START OF IGNITION IMMOBILISATION

15 sec after the activation of the external signalling (siren, horn, direction indicators) without the correct password being keyed in, the ignition immobilisation relay will be intermittently and progressively piloted for 3 minutes and the alarm cycles will continue. This operating mode will also result in the gradual slowing down of the vehicle's speed, in the countries where this is allowed, if the above relay intervenes either on the fuel pump or the +15.

The gradual reduction in speed will continue until the maximum limit is reached (see function 20). Once this speed has been reached, no further action will take place on the engine immobilisation if it is not exceeded. If the instrument panel is turned off (+15 OFF), the external signalling will stop and the engine can be turned on again within 60 sec (it is possible to accelerate until the maximum speed limit is reached, then the engine immobilisation relay will intervene intermittently).

If the correct password is keyed in when the instrument panel is on (+15 ON), this function is neutralised.

If the wrong password is keyed in when the instrument panel is on (+15 ON), the system goes onto the next stage.

COMPLETE ENGINE IMMOBILISATION

60 sec after the instrument panel has been turned off (+15 OFF), it will no longer be possible to start the engine up again. If the correct password is keyed in when the instrument panel is on (+15 ON), this function is neutralised. The system can also be neutralised using the RESTORING THE OVERRIDE CODE procedure (refer to relative section).

TEMPORARY BLOCK

If 3 wrong codes are keyed in consecutively, the system enters a temporary blocked mode and does not accept any further attempts for 10 minutes, making 3 consecutive Beeps every 5 sec (the instrument panel must remain switched off +15 OFF). It is possible to key the correct password in only at the end of this timed stage with the instrument panel turned on (+15 ON). If a further 3 wrong codes are keyed in, the temporary blocked mode will last for 20 minutes, then 30 minutes...

NEUTRALISING THE ANTI CARJACKING

By keying in a 4-digit password on the KEY PAD 4 when the instrument panel is turned on (+15 ON). If the correct code is keyed in, a long BEEP will be heard, whereas the wrong code will result in 3 consecutive Beeps.

18 - SIREN SUPPLIED - Factory Setting: according to the type of siren supplied

The alarm system can be supplied with either the M02 siren or the SC1 siren with battery back up. If you want to change the siren supplied with the other version, the setting of this function must be changed accordingly.

19 - KEY 4 KEYPAD - Factory Setting: disabled

The keypad replaces the LED/SWITCH and electronic emergency keys set (which can not operate together with the keypad). It is complete with a LED for signalling the status of the alarm system, a buzzer and 4 backlit keys (these light up the first time one of them is pressed and remain lit for 15 seconds after they were pressed for the last time).

20 - SAFETY LOCK CONTROL - Factory Setting: mileometer











See function 3

21 - DISTRACTION-PROOF REARMING FUNCTION - Factory Setting: disabled

This function enables the control unit to rearm the alarm system completely 2 minutes after it was last disarmed by remote control, provided the status of the doors, boot and bonnet remains unchanged during this time. If the volumetric protection was excluded when the system was previously armed, it will be excluded again when the system is automatically rearmed.

22 - FUNCTION OF REMOTE CONTROL BUTTONS

The way the buttons on the alarm system's remote control operate can be customised as shown in the table below: the system is supplied with the complete set of factory settings.

FUNCTION	FACTORY SETTING	CUSTOM SETTING
ARMING: with manual and automatic comfort closing of electric windows, if selected by installer	 BUTTON A	 BUTTON A
DISARMING: the system will rearm completely unless you enter the interior within 2 minutes and the distraction-proof function is enabled	 BUTTON A	 BUTTON B
EXCLUSION OF ULTRASONIC VOLUME PROTECTION AND AUXILIARY MODULES: press within 25 sec. of arming	 BUTTON B 1st press US 2nd press auxiliary modules	 BUTTON A 1st press US 2nd press auxiliary modules
STOP ALARM CYCLE: without disarming the system	 BUTTON B	 BUTTON A
PANIC: can be triggered when control unit is armed, after initial immunity time, max 10 sec. duration, can be stopped	 BUTTON B Can also be triggered if control unit is disarmed	 BUTTON A

23 - PASSIVE ARMING WITH ALARM FUNCTIONS - Factory Setting: disabled

This allows the peripheral protection of the alarm system to be armed automatically 30 seconds after the last open door is opened and the instrument panel is switched off (+15 OFF). The direction indicators flash 2 times to signal the system is armed and the LED flashes very quickly during the initial immunity time to indicate that the volume protection is not operational. After the initial immunity time, any alarm stimulus will trigger a PRE-ALARM signal lasting 5 seconds during which the siren will make a series of BEEP sounds: if the system is not disarmed before this time is over, a full alarm cycle will be triggered at the end of the pre-alarm signal. The alarm can be disarmed by means of the remote control.

Automatic passive arming can be temporarily neutralized with the garage function (see relative section)

24 - PASSIVE ARMING OF IMMOBILISER - Factory Setting: disabled

This allows the immobiliser to be armed automatically by the control unit:

- 4 minutes after the engine has been turned off, or

- 50 seconds after a door has been opened if the engine has been turned off

Automatic passive arming can be temporarily neutralized with the garage function (see relative section)

25 - PERIPHERAL ALARMS ACTIVE - Factory Setting: derived (1 alarm only)

It is possible to choose if an ongoing alarm trigger is to correspond to a single alarm cycle, or to consecutive alarm cycles up to a maximum of 10 (European Directive)

THE OVERRIDE CODE

In emergency situations, the alarm system can be neutralized by means of the OVERRIDE code. This is keyed in by using the button on the SWITCH/LED mounted on the dashboard or via the KEY4 keypad, if present. The code set during production in the factory is the same for all control units, i.e. 1 1 1 1 1 or 1111 if the keypad is enabled.

It is absolutely essential to customise this code; ask the owner of the vehicle for a sequence of 5 digits of his choice, not including 0, if the SWITCH/LED is mounted. If the keypad has been mounted the code has 4 digits made up of the keys 1, 2, 3 and 4 on the keypad. This code must be stored in the control unit's memory as shown in the procedure below, and then noted on the OVERRIDE CARD provided with the system and kept in a safe place by the owner of the vehicle.
CUSTOMISING THE OVERRIDE CODE WITH SWITCH/LED

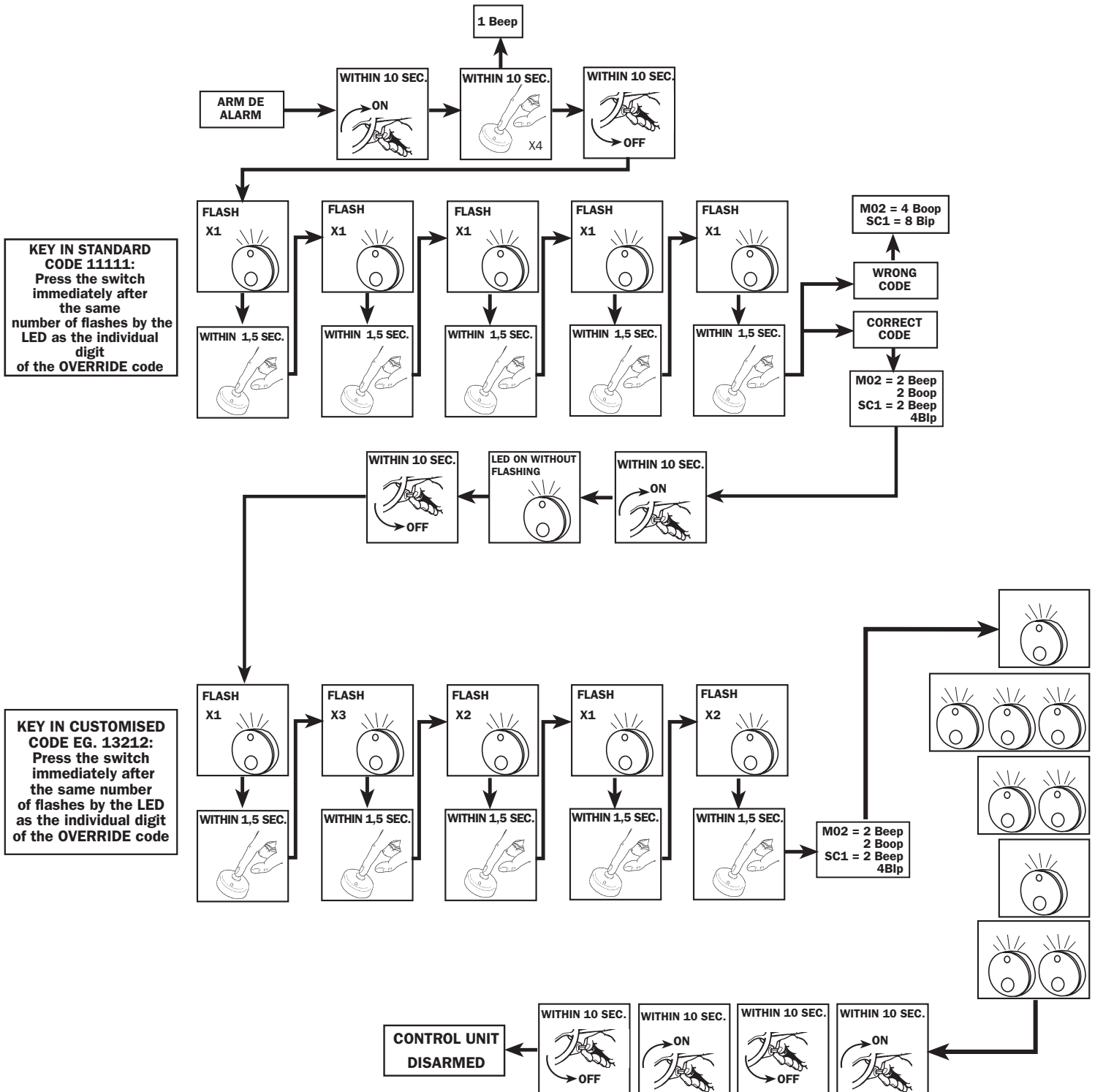

CUSTOMISING THE OVERRIDE CODE WITH KEYPAD

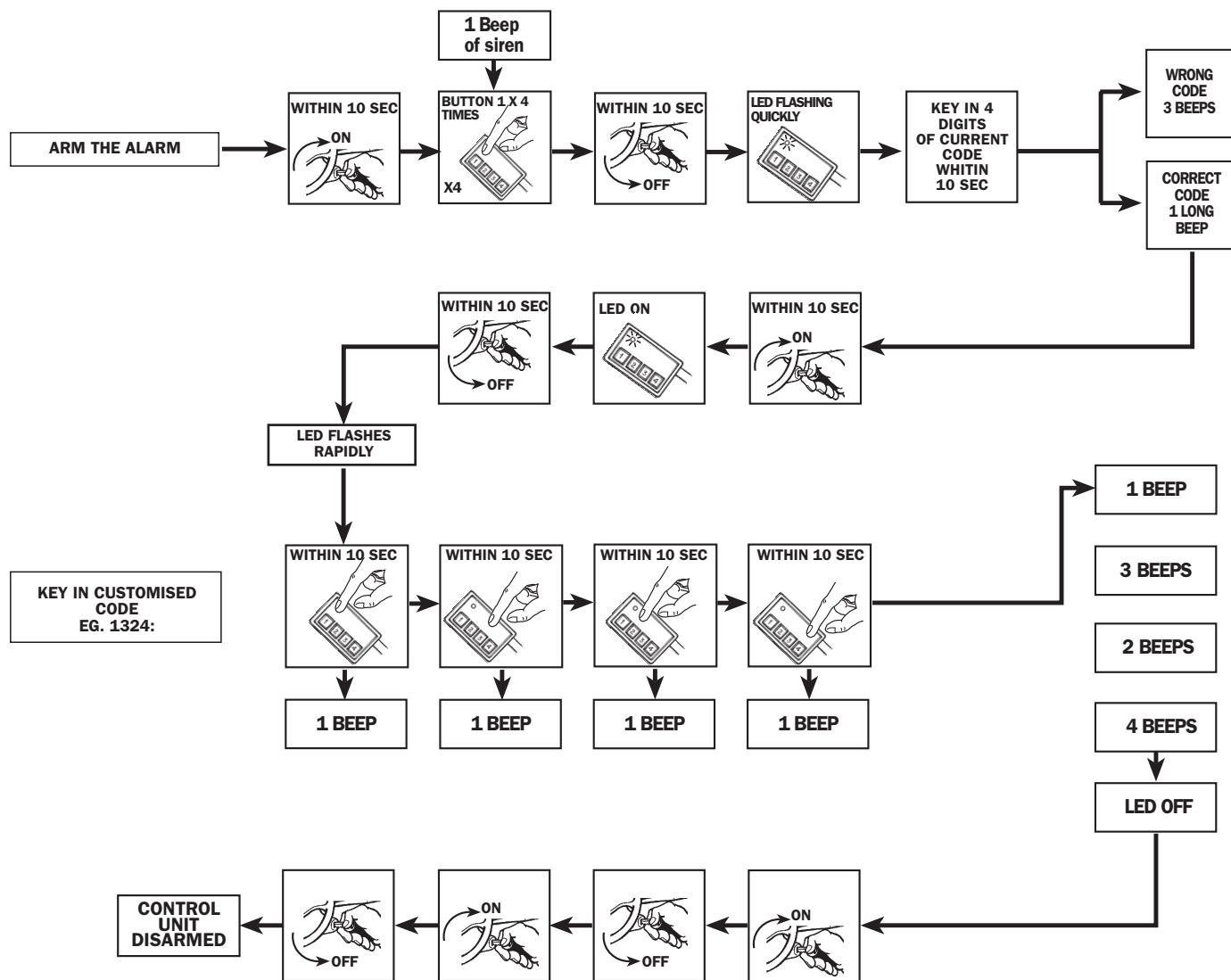

USE OF THE OVERRIDE CODE

This procedure is only operational after the initial immunity time or after the anti carjacking protection has become operative. Alarm cycles will be triggered as the code is being keyed in. If the LED/SWITCH does not work, it is also possible to insert the code by turning the vehicle's ignition key ON and OFF instead.

When the alarm system is armed, or when the anti carjacking protection is operational, follow the procedure illustrated below to disarm the H.P.A. control unit.

LED/SWITCH PROCEDURE

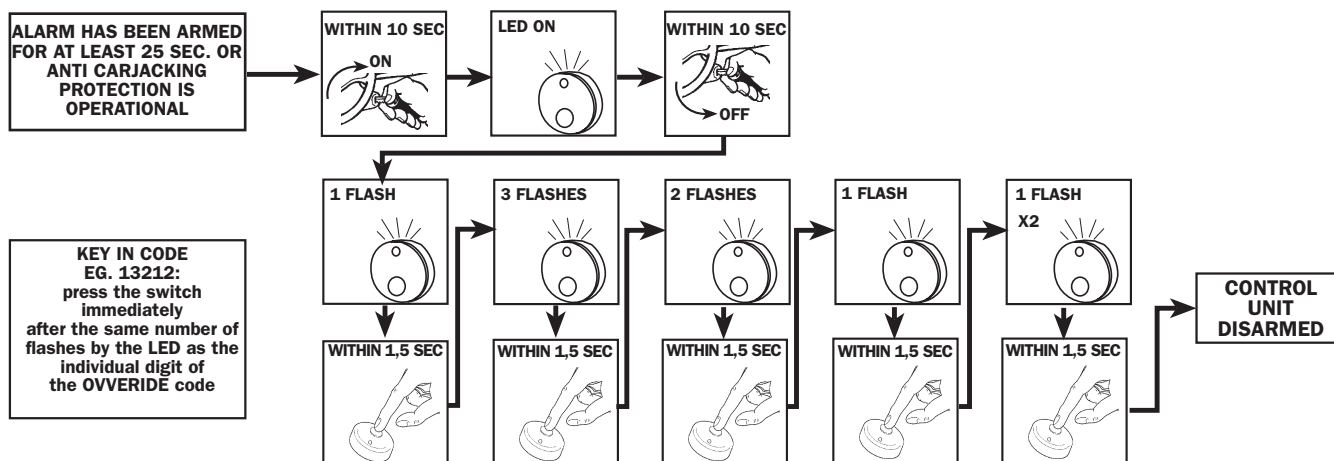

KEYPAD PROCEDURE

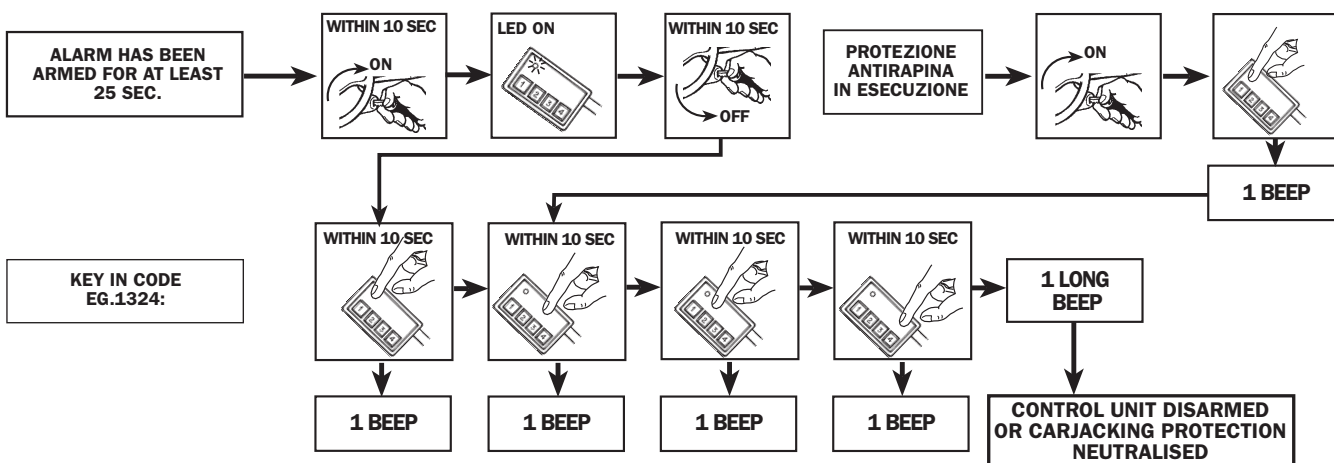

WARNING: if the wrong code is keyed in 3 times, the control unit will be blocked for 10 minutes to prevent attempts to acquire the code.

RESETTING THE OVERRIDE CODE

Should the code be lost or forgotten, the 1 1 1 1 1 factory set code, or 1111 with keypad, can be restored, and the owner's new code stored in again. This operation is not feasible if the system is armed (it must first be disarmed) but it can be implemented if the vehicle is blocked or if there is an anti-carjacking alarm. In automatic anti-carjacking 2 mode, it is only possible to implement it in the final, temporary immobilisation stage. This operation does however allow you to exit the anti-carjacking phase. You must have both remote controls to do this and follow the procedure below:

- disarm the control unit;
- turn the vehicle's ignition key ON (dashboard turned on);
- press button A on one of the 2 remote controls;
- press button A on the second remote control;
- press button A on the first remote control again;
- press button A on the second remote control again. The M02 siren will now confirm that the code has been reset by sounding 2 BEEPS followed by 2 BOOPS. The SC1 siren will make 2 BEEPS followed by 4 BIPS.
- turn the vehicle's ignition key OFF (dashboard turned off);

N.B. Make sure that less than 5 seconds pass between one step and the next.

REMOTE CONTROLS

The alarm control unit is supplied with 2 coded remote controls but it is possible to add extra remote controls, up to a maximum of 7 in all. To add new remote controls, they must first of all be ordered from your local MetaSystem Customer Care Centre; you must indicate the base code, located on the red card supplied with the product, on your order. After you receive the remote controls, they have to be linked up to the control unit by means of the dedicated link-up procedure. If one or more remote controls are lost or stolen, they can be cancelled by means of this same link-up procedure, and even reset for use should they be found again.

LINKING UP REMOTE CONTROLS

- a) arm and disarm the control unit with the remote control for a total of 16 times in all. The M02 siren will now make 2 BEEPS followed by 2 BOOPS. The SC1 siren will make 2 BEEPS followed by 4 BEEPS;
- b) turn the ignition key ON within 10 secs (vehicle's dashboard is turned on);
- c) press button A on the new remote control: the LED turns on;
- d) press button A on the same remote control again: the LED turns off and the siren makes a BEEP to confirm it has been successfully linked up;
- e) press button A on the second new remote control: the LED turns on;
- f) press button A on the same remote control again: the LED turns off and the siren makes a BEEP to confirm it has been successfully linked up;
- g) repeat steps e and f for all the new remote controls;
- h) turn the ignition key OFF (vehicle's dashboard is turned off): the M02 siren will make 2 BEEPS and 2 BOOPS to signal the remote controls have been stored in the control unit's memory; the SC1 siren will make 4 BIPS.

EMERGENCY KEYS

The alarm system can be equipped with up to 4 electronic keys for emergency disarming.

The EMERGENCY KEYS KIT (P64760) includes the receptacle, to be installed as shown in fig. 1/A, and 2 keys, which must be stored in the control unit's memory as described in the procedure for memorising emergency keys. It is also possible to neutralize any lost or stolen keys by means of the same procedure, as the memorising of emergency keys automatically deletes any previously stored keys.

MEMORISING EMERGENCY KEYS

- a) arm the control unit with the remote control;
- b) within 10 seconds of this, turn the vehicle's ignition key ON (dashboard is turned on);
- c) within 10 seconds of this, press the button on the SWITCH/LED 4 times: the siren will BEEP once to confirm selection;
- d) within 10 seconds of this, turn the vehicle's ignition key OFF (dashboard is turned off): the LED will start to flash slowly thus requesting the override code. The button must be pressed immediately after the equivalent number of flashes of the LED as each individual digit in the override code;
- e) The M02 siren will make 2 BEEPS followed by 2 BOOPS to confirm the correct override code; the SC1 siren will make 2 BEEPS followed by 4 BIPS;
- f) insert the emergency keys into the receptacle within 10 seconds: the LED will flash once to confirm each key has been memorised correctly;
- g) turn the vehicle's ignition key on and off three times each to exit the procedure and finalise the storing of the emergency keys in the control unit's memory.

CHECKING THE QUANTITY OF REMOTE CONTROLS AND EMERGENCY KEYS

When the alarm system is disarmed, turn the vehicle's ignition key ON (dashboard is turned on) and press button A on the remote control: the LED will flash the same number of times as the number of remote controls that are stored in the control unit's memory. After a pause of 2 seconds, the flashing will start again to indicate how many emergency keys have been stored in its memory.

MEMORISING THE MILEOMETER FREQUENCY

This enables the memorisation of the frequency of the signals found on the mileometer wire, relating to:

- a) vehicle immobile with engine running (speed 0);
 - b) threshold for activation of intentional carjacking, maximum speed allowed by the ANTI-CARJACKING 1 function .
- It is essential to enable the mileometer input for function 20. It is possible to execute it if any enabled anti-carjacking functions are not operational (they must therefore be neutralised using the relative procedures)

Type 'a' memorisation alone can be done if the LED/SWITCH is mounted:

- with the control unit disarmed, turn the instrument panel on (+15 ON) and turn the engine on;
- within 10 sec of this, press the button on the LED/SWITCH 10 times: the direction indicators flash every time it is pressed, then the siren produces a BEEP the tenth time and the LED flashes rapidly;
- within 10 sec of this, press the button on the LED/SWITCH to store the frequency at zero velocity: the siren produces a BEEP and the LED turns off
- turn the engine and the instrument panel off (+15 OFF)

Types 'a' and 'b' memorisation can be done if the keypad is mounted:

- with the control unit disarmed, turn the instrument panel on (+15 ON) and turn the engine on;
- within 10 sec of this, press two buttons on the keypad at the same time and keep them pressed for at least 10 sec. After 10 sec have passed, the buzzer on the keypad will produce 4 short BEEPs and when the buttons are released the LED will light up without flashing.
- within 10 sec of this, key in the 4-digit override code and make sure that less than 10 seconds pass between pressing one button and the next. If more than 10 seconds pass, a BIP sound will signal the need to repeat the procedure from the beginning. A long BEEP confirms the correct code has been received and the LED turns off.
- press any key on the keypad to store the speed when the vehicle is not in motion: 2 consecutive BEEPs confirm it has been stored successfully. Turn the vehicle's engine on and take it to the required speed (recommended 30Km/h), then press any button on the keypad to store the speed, 2 consecutive BEEPs confirm it has been stored successfully.
- stop the vehicle and turn off the engine and instrument panel (+15 OFF) to complete the procedure.

THE GARAGE FUNCTION

The function makes it possible to temporarily neutralize the passive arming of the engine immobiliser, the passive arming with the alarm functions, distraction-proof re-arming and anti carjacking protection.

If the anti carjacking protection has not yet been enabled, the garage function is enabled by pressing button A on the remote control together with the button on the SWITCH/LED mounted on the dashboard: the direction indicators flash 2 times and the siren makes 1 BEEP to confirm the function is operational. If the ignition key is turned ON (dashboard is turned on), the LED will flash to warn that the garage function is operational.

If the anti carjacking protection has already been enabled, the garage function is enabled by pressing button A on the remote control at the same time as the anti carjacking switch. The signals given after this are the same as those described above.

If the keypad has been mounted, press 2 any keys at the same time and press button A on the remote control to transmit a signal: the keypad will produce 4 BEEPs to confirm reception. Release the 2 buttons and key in the override code within 10 sec: the direction indicators flash 2 times and the siren produces 2 BEEPs to confirm the function has been activated. It is possible to turn the ignition on 15 times when the garage function is operational and will remain memorised, even if the alarm control unit's power supply is disconnected. To exit the garage function, arm the alarm system with the remote control.

THE CONTROL UNIT'S POWER SUPPLY

If the control unit's power supply is disconnected, its memory will store its previous status. When its power supply is restored, the status of the control unit will be the same as just before the power supply was disconnected.

MEMORY OF TRIGGERED ALARMS

If various alarms have been triggered, the memory will signal them in sequence with 3 second pauses, and repeat the sequences every 6 seconds. The memory is reset when the vehicle's ignition is turned on or when the control unit is armed again by remote control.

LED SIGNAL	TYPE OF ALARM TRIGGERED
1 FLASH	ULTRASONIC
2 FLASHES	DOORS
3 FLASHES	BONNET
4 FLASHES	BOOT
5 FLASHES	AUXILIARY MODULES (POSITIVE ALARM)
6 FLASHES	DASHBOARD (+15)
7 FLASHES	CURRENT DROP SENSOR

FINAL CHECK

After the alarm system has been installed and customised, it is important to check that it operates correctly by means of the following procedure:

- connect the cable's connector to the HPA control unit
- close the boot, sun-roof, all windows and doors
- make sure that you have not left the car keys or the remote controls inside the vehicle
- restore the connection of the car battery, then close the bonnet
- the first time it is switched on, the control unit will be disarmed
- start up the engine to check that all connections have been carried out correctly











The checks described below refer to a control unit with standard factory settings: the results of the various steps may vary according to any customisation of the operating functions.

- arm the control unit by pressing button A on the remote control: the doors are locked by the central door locking system, the alarm protection is operational, the direction indicators flash 2 times and the LED flashes
- during the initial 25 seconds of immunity time, complete the following tests, each of which should cause the indicators to flash once, signalling the positive outcome of the test:
 - open a door, the bonnet and the boot
 - turn the ignition key ON
 - insert your hand through an open window and move it backwards and forwards compared to the installed ultrasonic capsules; the initial immunity time starts again from zero every time the indicators flash
- after the initial immunity time is over, the LED will flash more slowly and there will be a 25 second alarm cycle if you trigger any of the alarm's protection features: the siren produces its distinctive modulated sound, the direction indicators flash and the horn, if connected, sounds intermittently. Check that the immobiliser is working properly during an alarm cycle.
- disarm the alarm control unit by pressing button A on the remote control: the doors are unlocked via the central door locking system, the direction indicators flash once, the MO2 siren produces 1 BOOP sound, whilst the SC1 siren produces 2 BIPS, and the LED flashes to indicate the memorised alarms which took place during the final check. Refer to the relative section for more information on what these flashes stand for.

Please refer to the instructions of the individual auxiliary modules for more information on their operation, if any are installed.



INSTRUCTIONS FOR USE

MAIN CONTROLS AND SIGNALS (* configuration must be made)

FUNCTIONS	FACTORY SETTING	*CUSTOM SETTING	INDICATORS	SIREN	LED
ARMING: with manual and automatic comfort closing of electric windows if selected by installer.	 BUTTON A	 BUTTON A	2 FLASHES	2 BEEPS (if buzzer ON*) if peripheral protection is active: M02= 1 BOOP, SC1= 2 BIPS	FLASHING: turns off briefly during first 25 sec. (initial immunity time), then flashes slowly
DISARMING: if you don't get inside the car within 2 minutes when the distraction-proof function has been enabled, the system will completely disarm. The system is completely disarmed during an alarm.	 BUTTON A	 BUTTON B	1 FLASH	1 BEEP (if buzzer ON*) and no alarms were triggered. If alarms were triggered (after the BEEP if buzzer ON*): M02= 1 BOOP, SC1= 2 BIPS 1 BEEP + 4 rapid BEEPS if car battery is flat and buzzer ON*	Turns off if no alarms were triggered, otherwise flashes to signal memorised alarms (see relative table)
EXCLUSION OF ULTRASONIC VOLUME PROTECTION AND AUXILIARY MODULES: press within 25 sec. of arming.	 BUTTON B 1st press US 2nd press auxiliary modules	 BUTTON A 1st press US 2nd press auxiliary modules	3 FLASHES EACH TIME BUTTON IS PRESSED	3 BEEPS each time button is pressed (if buzzer ON*)	FLASHING: rapidly during first 25 sec. (initial immunity time) then flashes slowly
STOP ALARM CYCLE: without disarming the system	 BUTTON B	 BUTTON A	FLASHING STOPS	SOUNDING STOPS	FLASHING: Flashes slowly
* PANIC: can be activated when control unit is armed, after initial immunity time, max duration 10 sec., can be interrupted by pressing same button	 BUTTON B BUTTON B can also be activated when control unit is disarmed	 BUTTON A	FLASHING	SOUNDING	Same as previous status

ADDITIONAL SIGNALS (*configuration must be made)

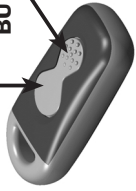
FUNCTIONS	INDICATORS	SIREN	LED
ALARM: 25 sec. cycle can be stopped by remote control	FLASHING	SOUNDING	OFF
* PASSIVE ARMING OF ENGINE IMMOBILISER: arms 4 minutes after the engine is turned off, or 50 sec. after a door is opened (with engine off).	1 FLASH	—	Flashing very slowly
* PASSIVE ARMING OF ALARM + IMMOBILISER: arms 60 sec. after opening and closing a door (with engine off).	2 FLASHES	—	Flashing very slowly during first 25 sec. (initial immunity time)
PRE-ALARM: only if passive arming of alarm has been enabled or if armed by electronic key. An alarm cycle is produced after 5 sec.	—	Series of BEEPS for 5 sec.	Same as previous status

<p>GARAGE FUNCTION</p> <p>Enables the passive arming of the engine immobiliser, passive arming of alarm, distraction-proof re-arming and anti-cjacking functions to be temporarily neutralised. If the garage function is enabled, the engine can be turned on 15 times and remains memorised even if the alarm control unit's power supply is disconnected.</p> <p>When the ignition key is ON (instrument panel ON) the LED will flash to indicate that the garage function has been selected. Use of remote control will cancel this setting.</p> <p>LED/SWITCH:</p> <p>press button A on the remote control and the button on the LED, the direction indicators will flash once, the M02 siren will produce 1 BOOP sound whilst the SC1 siren will produce 2 BIP sounds.</p> <p>KEY4 Keypad:</p> <p>press 2 buttons on the keypad at the same time and press button A on the remote control to transmit a signal: the keypad will produce 4 BEEPS to confirm reception. Release the 2 buttons and key in the override code within 10 sec: the direction indicators flash 2 times and the siren produces 2 BEEPS to confirm the function has been activated.</p>	 <p>TX mykro</p>  <p>M252</p>
--	---

The best technology for your security



www.metasystem.it

MetaSystem S.p.A. • Via Oberdan
42100 Reggio Emilia • ITALY
Tel. +39-0522 364 111 • Fax +39-0522 364 150
info@metasystem.it

